

3-PORT, CENTER

TALON
 MFR-18-2-2-1-X-X
 MODULAR FLOW RESTRICTOR
 1.125" W-SEAL

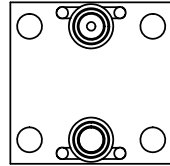

2-PORT, SIDE

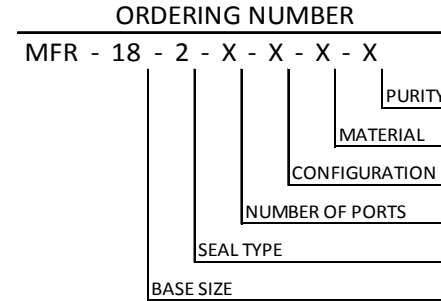
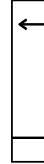

TALON
 MFR-18-2-3-1-X-X
 MODULAR FLOW RESTRICTOR
 1.125" W-SEAL

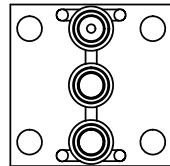

3-PORT, SIDE

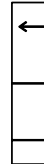

BASE SIZE	SEAL TYPE	NUMBER OF PORTS	CONFIGURATION	ORDERING NUMBER
1.125"	W-SEAL	2-PORTS	SIDE	MFR-18-2-2-1-X-X
		3-PORTS	SIDE	MFR-18-2-3-1-X-X
			CENTER	MFR-18-2-3-2-X-X

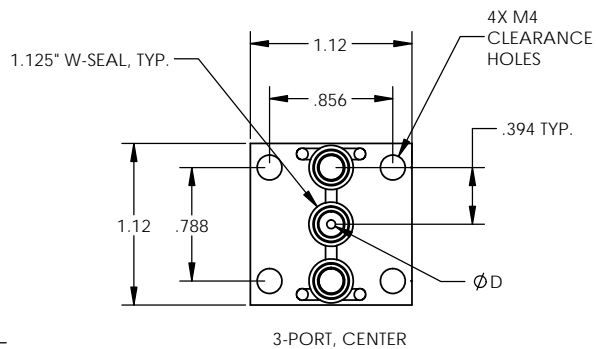

3-PORT, CENTER

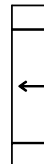

MATERIAL DESIGNATORS

- S = 316L SST SEMI F20
- A = 316L
- B = 316L SST SEMI F20 VIM/VAR
- N = NICKEL 200
- M = NICKEL 400
- H = NICKEL ALLOY C22

PURITY DESIGNATORS

- S = STANDARD FINISH
- H = HIGH PURITY
- U = ULTRA-HIGH PURITY

*WHEN ORDERING, MUST SPECIFY ORIFICE DIAMETER [D] OR THE FOLLOWING:
 GAS TYPE, FLOW RATE, INLET PRESSURE, AND OUTLET PRESSURE.

- NOTES:
- DRAWINGS FOR SPECIFICATION PURPOSES AND ARE FOR REFERENCE ONLY.
 - ALL VERSIONS OF THE DRAWING ARE SUPERSEDED BY THIS RELEASE AND SUBJECT TO CHANGE WITHOUT NOTIFICATION.

EFFECTIVE DATE: 2/6/2017		 INNOVATION WITH PRECISION	1003 INDUSTRIAL DRIVE SAUK RAPIDS, MN 56379 VOICE: 320-251-0390 FAX: 320-251-5810	
INTERPRET DRAWING PER: ASME Y14.5 - 2009			THIRD ANGLE PROJECTION	
THIRD ANGLE PROJECTION			DESCRIPTION: MODULAR FLOW RESTRICTOR 1.125" W-SEAL	
PROPRIETARY AND CONFIDENTIAL THE INFORMATION CONTAINED IN THIS DRAWING IS THE SOLE PROPERTY OF TALON INNOVATIONS, INC. ANY REPRODUCTION IN PART OR AS A WHOLE WITHOUT THE WRITTEN PERMISSION OF TALON INNOVATIONS, INC. IS PROHIBITED.		SIZE: C	PART NUMBER: MFR-18-2-X-X-X-X	
DO NOT SCALE DRAWING		SCALE: 3:2	SHEET 1 OF 1	